



瑾 坤

产品目录

G r e e n C o a s t C a t a l o g u e

目录

Contents



关于我们
About us



核心业务
Core Business



市场推广
Achievements



品牌集合
Brands Hub



关于我们

About us



2011

宁波林可斯特食品
有限公司成立

代理“美国爱乐压”品牌

2012

台湾
Mr.Clever品牌

2013

正式引入W.A.C.
(世界爱乐压大赛)

由我司每年举办W.A.C.中国赛区

2014

美国acaia品牌
日本Rivers品牌

2016

日本KINTO品牌

2017

宁波宁珂斯特贸易
有限公司成立

主营：咖啡器具、杯具等精品家居用品
品牌：总代理各国家和地区12个新潮品牌

2018

正式投入公益项目
“手心咖啡计划”

2019

美国MiiR品牌

2021

加拿大VSSL品牌

2022

新成立
宁波市瑾坤科技发展
有限公司

核心业务

Core Business — 业务渠道



线下实体



商超、咖啡馆、家居馆、书店

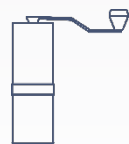

线上网络



天猫、淘宝、京东、小红书等



B端客户



机场、礼品公司、酒店、连锁店

核心业务

Core Business — 品牌定制



1

确定产品

先选择产品
提供定制信息及
图稿文件(矢量图稿)

2

订单确认

确认定制订单
确认定制图稿
(尺寸、颜色、位置)

3

最后制作

工厂排单制作
密切跟单确保订
单无误完成及发货

丝网印刷

- 可多色多面印刷
- 适用于品牌:
Rivers/MiiR/KINTO/聪明杯

激光雕刻

- 通过去除粉末涂层来制作
- 适用品牌:
Rivers/MiiR/KINTO

自定义产品

- 定制数超过1000个,
可专属定制杯子颜色。
- 适用品牌 :Rivers/MiiR

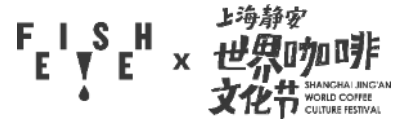

市场推广

Achievements



社交媒体

—
小红书
新浪微博
杂志媒体
微信公众号



展会/咖啡节

—
ISPO亚洲运动用品与时尚展
HOTELIX
上海国际酒店及餐饮业博览会
中国（深圳）
国际礼品及家居用品展览会



赞助项目

—
烘焙比赛
CAFEEX深圳咖啡饮品展



公益项目

—
“Brew by Heart”计划
(帮助视障人士实现咖啡师的梦想)



品牌集合
Brands Hub

KINTO

Rivers

acaia

Clever

HANDYBREW
good consistent tea made simple

VSSL

MiiR[®]

**PUCK
PUCK**

bruер

ACME & CO.

VSSL



VSSL JAVA手摇磨豆机

/终极手动磨豆机，专为户外爱好者设计，随时随地享受升级的咖啡体验。

/超耐用：坚固的航空级铝制成，陪你应付任何冒险。

/最佳研磨：50种独特的研磨设置，选择最佳冲泡研磨度。可扩展手摇手柄符合人体工程学的抓地力，可在一分钟内完成20g的研磨。

/易于使用和便携：独特的可翻转钩扣设计，可轻松固定在包上，通过90公斤的承重测试，可随心所欲地打包和玩耍。磨豆机盖可轻松按弹，快速地添加豆子。

品牌：加拿大

材质：航空级铝

重量：396g

尺寸：15.3*5.2cm

起订：12个

产地：中国



JAVA手摇磨豆机
零售价：1680元

Mr.Clever®



Mr.Clever 聪明杯

- /台湾EK Int'l公司发明
- /结合法压壶和手冲壶的优点
- /操作简便，浸泡萃取，出品更定
- /美国Tritan材质，高品质食品级树脂，透明、耐热、不含双酚A。

有一种简单，叫聪明杯！
简单易用，兼顾风味，风靡全球！



品牌/产地：台湾

材质：Tritan Copolyester

重量：201g(小款)

208g(大款)

尺寸：D110mm*H90mm(小款)

D135mm*H145mm(大款)

箱规：12个



大款聪明杯套装（100片滤纸）

零售价：¥228



小款聪明套装（100片滤纸）

零售价：¥192

HANDYBREW
good consistent tea made simple



HandyBrew 台湾滤茶器

- /提供客制服务
- /与全球多个知名品牌做联名款
- /有专利设计“智慧止水活塞”
- /操作简单 轻松萃取专业级茶品
- /获得全球10余个国家地区的发明奖项
- /畅销美国、法国、加拿大、日韩、英国等全球10余个国家和地区。
- /美国Tritan材质，高品质食品级树脂，透明、耐热、不含双酚A。

HandyBrew专利与奖项

- 荣获伦敦国际发明展金奖
- 荣获新加坡Optimal金奖
- 荣获匈牙利发明家协会颁发之天才奖
- 荣获第17届美国匹兹堡发明展INPEX金奖
- 荣获德国纽伦堡国际发明展金奖
- 荣获中国全国发明展览会金奖
- 荣获中国北京国际科技产业博览会金奖
- 荣获瑞士日内瓦国际发明展金奖
- 荣获香港世界华人发明博览会金奖
- 荣获台湾经济部设计优良产品证书
- 荣获台湾精品奖
- 荣获上海国际发明展金牌奖

品牌/产地：台湾
材质：Tritan
Copolyester
箱规：30个
零售价：¥235



HB.C-70728L



HB.C-70598XL



HB.C-70968L

bruering



Cold Bruer 冰滴壶

/美国原装进口

/体化简约设计

/专利滴水阀门，均衡滴速

/20多次的迭代升级，咖啡界炙手可热

无称设定水粉比

水仓和粉仓1:12设计刻度线

恒温萃取

可放入冰箱萃取



品牌地：澳大利亚

产地：中国

容量：720ml

材质：食品级不锈钢、硅胶和高耐热玻璃

粉仓：60g

尺寸：H250mm*D120mm



零售价：¥689



**PUCK
PUCK**



PUCK PUCK 爱乐压冰滴配件

- /专利滴滤调节阀门
- /轻巧便携，出品稳定
- /可连接APP，调节水流速度
- /通用螺纹，可与矿泉水瓶配对
- /专为爱乐压设计，搭配使用简单又经济

爱乐压也能做冰滴！
随时随地享受美味的冷萃咖啡！

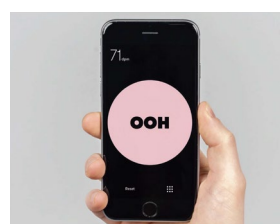

品牌：美国
产地：中国
材质：食品级（不含BPA）塑料
尺寸：2.4厘米高，6.8厘米宽
箱规：12个



冰滴环+冰斗
零售价：269元



冰滴环
零售价：188元

acaia



Acaia Pearl 手冲电子秤

- /支持IOS、AndroidBluetooth4.0连接
- /精准测量，计时功能定期校正，最小单位精确到0.1g
- /精密设计最新防水工艺，体积小，易携带
- /多种冲煮方式、闹钟提醒、粉水比例、记录分享等多功能

品牌地：美国
 产地：中国台湾
 参数：0.1g~2000g
 电池：锂电池（可充电）
 尺寸：160mm(W) x 160mm(L) x 32mm(H)
 箱规：5个



白色
零售价：1480元



黑色
零售价：1580元

Acaia Pearl S 手冲电子秤

- /pearl系列的再升级
- /适合选手比赛训练
- /实时显示水流速度
- /轻松分享咖啡冲煮指南



品牌地：美国
 产地：中国台湾
 参数：0.1g~3000g
 电池：锂电池（可充电）
 尺寸：160mm(W) x 160mm(L) x 32mm(H)
 箱规：5个



白色
零售价：1980元



黑色
零售价：1980元

acaia



Acaia Lunar 意式电子秤

- / 专为意式咖啡机打造
- / 阳极氧化铝外壳，防水涂层液晶显示屏，防溅水
- / 高灵敏度和高精度，出品稳定
- / 美国设计，台湾生产智能关机，节能环保

品牌地：美国
产地：中国台湾
参数：0.1g~2000g
电池：锂电池（可充电）
尺寸：105mm(W) x 105mm(L) x 15.5mm(H)
箱规：5个
(可搭配acaia配件使用)

黑色
零售价：2500元



银色
零售价：2500元



白色
零售价：2658元



acaia



Acaia Pyxis 极小电子秤

- /全球最小电子秤
- /三种显示模式
- /称重可低至0.01克至500克
- /自带保护盖轻巧便携



黑色
零售价：2658元

品牌地：美国
产地：中国台湾
参数：0.01g~515g
电池：锂电池（可充电）
尺寸：65mm(W) x 65mm(L) x 13mm(H)
重量：70g±5g
箱规：5个



Acaia Orion 定量分选秤

- / SCA2017最佳新产品奖
- /显示直观，全自动灵活称豆
- /可储存3种称重量
- /大小2种豆仓选择

品牌地：美国
产地：中国台湾
参数：0.1g~3000g
电池：锂电池（可充电）
尺寸：335mm(W) x 200mm(L) x 360mm(H)
305mm(W) x 200mm(L) x 360mm(H)
箱规：1台



白色 大底座
零售价：9000元



白色 小底座
零售价：9000元



银色 大底座
零售价：8000元



银色 小底座
零售价：8000元



Acaia Ion Beam 去静电离子器

/减少研磨产生的静电，减少咖啡粉飞粉、结块等，桌面更干净。

/配置红外传感器，能感应5厘米以内的物品。简化研磨过程，以提高效率。

/两端一正离子和一负离子可以有效中和静电电力，解决了负或正静态积累。

/轻巧便携，可手持可自配支架。

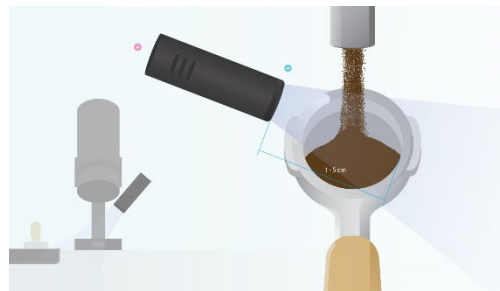

灰色

白色

黑色

零售价：1898元

品牌地：美国 产地：中国台湾
 重量：115g±5g
 尺寸：直径：42mm；长度：127mm
 电池：锂离子充电电池 3.7V 780mAh
 续航：8小时 连接性：蓝牙5.0 保修：1年

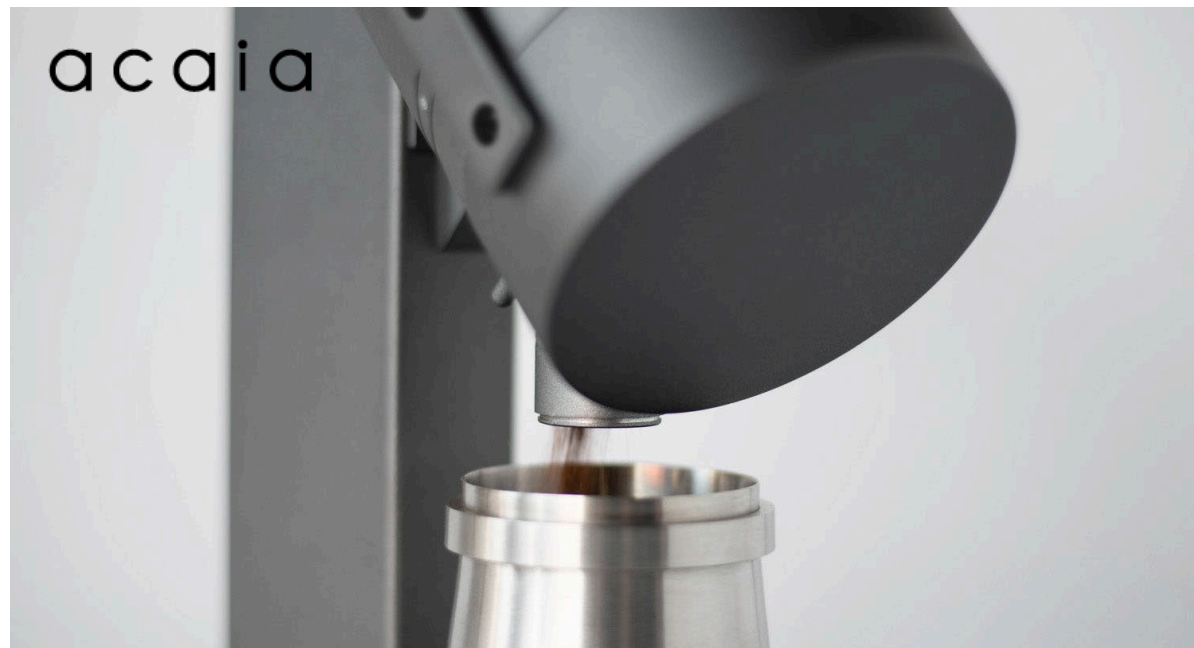

Acaia Orbit 咖啡研磨机

/可连接LUNAR咖啡秤，进准称量咖啡粉。

/64mm平面刀盘，两种刀盘供选择。

/0.75mm螺纹间距，精确调整咖啡研磨度。

/可连接APP自定义您的Orbit。

/降低能耗，同时提供工业高性能和更智能的研磨。



刀盘：MAZZER 33M

零售价：¥20000(预估)

刀盘：SSP MULTI-PURPOSE

零售价：¥21000 (预估)

品牌地：美国 产地：中国台湾
 频率：50/60Hz 工作温度：0-40℃
 重量：5600g ±10g
 材质：铝、PC、不锈钢
 额定电压：100V-240V
 尺寸：W108mm x L298mm x H394mm
 工作周期：建议运行时间60s，休息30s
 保修：1年





ODM设计师系列 新品

【Lock x Rivers】

当你忙于工作或其他事时，你早上在煮咖啡，你突然想，‘我最近没有露营……’。
 作家Lock创造了一个“户外怪物”。



ODM-贴纸

¥28 | 约W97mm × H75mm | 10片/包

氯乙烯树脂 | 中国制造

ODM-sleek 随行杯

¥128 | W90mm×D90mm×H130mm (孔径尺寸约90mm) | 118g

耐热度/150℃ 耐寒度/ -40℃
 聚丙烯 (杯、盖) / 热塑性弹性体 (盖) / 硅橡胶 (盖)
 请勿使用微波炉 | 中国制造



ODM-Stout Air 随行杯

¥158 | 550ml: 约W100mm (含表带) ×D71mm×H204mm (直径尺寸约50mm) | 135g

¥185 | 1000ml: 约W117mm (含表带) ×D85mm×H250mm (直径尺寸约50mm) | 178g

耐热度: 90℃ (瓶体)、140℃ (盖子)
 耐冷度: -40℃ (瓶体、盖子)
 共聚酯*PET (瓶体) / 聚丙烯 (盖子、防溅罩、环) / 硅橡胶 (带) / 不锈钢 (销)
 微波炉/洗碗机不能使用 | 中国制造





LOOP AIR-日常陪伴你的瓶子。

惊艳的“盖子”设计，有个“环形手柄”，用时可手提或者挂在别处，不用时可收纳入盖子中。瓶盖有连接环，拧下盖子也能连接着不怕丢。大小两个口径，宽口径：方便泡茶也易于清洗。窄口径：出门饮水不易洒。

Loop Air 随行瓶

¥118 | 500ml: W70mm× D70mm × H210mm | 116g

¥148 | 850ml: W81mm× D81mm × H250mm | 144g

口径尺寸都约21mm

耐热度：90℃（瓶体）、140℃（盖子） 耐冷度：-40℃（瓶体、盖子）

共聚酯*PET（瓶体）/聚丙烯（盖子、手柄）/不锈钢（销） | 中国制造

新品





因咖啡馆的外卖杯而启发灵感，双层杯壁设计，隔热防烫，无需纸套，手感温度适宜。外层磨砂质感，高级好抓握，人性化饮用口，饮用方便。密封设计，防漏且还具有一定的保温性能，颜色更多颜值高（右图为定制案例）。

WALLMUG SLEEK 随行杯

¥118
H130mm*D91mm | 300ml

杯身（食品级耐热PP聚丙烯）杯盖（硅酮橡胶） | 中国制造
耐热度 / 150℃ | 耐冷度 / -40℃ | 16/箱



© Disney



专为喜欢随身携带随行杯出外人士打造。100g 轻盈瓶身可容纳290ml 饮料。双层结构结实瓶身就算不小心掉落也不会摔坏。通过杯盖调解可直接饮用或使用吸管饮用（右图为定制案例）。

WALLMUG DEMITA 随行杯

¥98
W86mmxH121mm | 290ml

杯身（食品级耐热PP聚丙烯）杯盖（硅酮橡胶） | 中国制造
耐热度 / 130℃ | 耐冷度 / -40℃ | 16/箱





可以每天拿着走的水杯，双层隔热保冷、密封防漏设计，更便于外出携带，让鲜美长久。顶部引水口有专门的开口设计，喝水方便，不易烫嘴。底部防滑设计，更加稳固，配合便携式硅胶滤杯，简易收纳，方便携带（右图为定制案例）。

BEARL SOLID 随行杯

¥138
W91mm×H175mm | 400ml (可自配滤芯)



杯身（食品级耐热PP聚丙烯）杯盖（硅酮橡胶） | 中国制造
耐热度 / 120℃ | 耐冷度 / -40℃ | 16/箱





专为美味冷萃咖啡设计。自带滤芯，双层设计。底部专门为防滑设计，既可以装咖啡、果汁、饮料，还可以放冰箱夏日做冷泡茶。将咖啡粉放入专属滤芯，加入冷水，睡前放入冰箱，第二天早上就可以享用一杯完美的冷萃咖啡啦。

BEARL 带滤芯随行杯

¥168
W91mm×H177mm | 400ml



树脂(内杯、外杯) / 聚丙烯(盖子, 底部, 过滤器) / 硅橡胶(内杯、盖) / 尼龙(网眼)
耐热度/90℃ | 耐冷度/-40℃ | 16/箱 | 中国制造



便携方便旅游随性且实用，双层设计，隔热效果好，不烫手，同时还具备保温效果。底部专门为防滑设计，放在桌上更放心。顶部引水口设计，喝水方便不易烫嘴。既可以装咖啡、果汁、饮料，还可以放冰箱夏日做冷泡茶。

BEARL 随行杯

带图款：¥148
不带图款：¥138

W91mm×H177mm | 400ml (可自配滤芯)



树脂(内杯、外杯) / 聚丙烯(盖子, 底部, 过滤器) / 硅橡胶(内杯、盖)
耐热度/90℃ | 耐冷度/-40℃ | 16/箱 | 中国制造



新款不锈钢材质随行杯，更结实耐用，大杯口易清洗。杯盖的密封设计，出行更便携。杯底变窄处理，可车载使用。更大的出水口，目的是让饮品接触空气，在到达嘴唇之前冷却，也让饮品的香味能从出水口窜出，更好的享受饮品的味道和香气（右图为定制案例）。

Shade 随行杯

¥199

W81mm x D85mm x H141mm

(口径尺寸约 81mm) | 199g



新品

不锈钢（主体、盖）/聚丙烯（盖）/硅橡胶（盖） | 中国制造 | 24/箱





七个收纳袋，随意装备。有个“隔板”可调节，让产品收纳更便捷。

三个手提带，放取自如。分为“顶部”、“侧面”和“肩部”，可应对步行、骑行、汽车等携带咖啡用具的各种情况。

材质更耐磨损、耐撕裂、更易清洗，有一定防水性。

更有三角登山扣、防水拉链、夹子等小配件。

Coffee Gear Bag Roo 咖啡装备收纳包

¥399 | 约W220mm×D70mm×H170mm 表带总长度：700mm

重量：约240g | 存储容量：约2.6L | 承载力：2公斤
防撕裂尼龙、聚酯纤维（主体）、尼龙（衬里、表带）| 中国制造



超轻钛杯，有两个尺寸啦！钛材质耐磨损，不易导热，可明火直烤。

S 尺寸：34g，180ml。杯子+ 36gMCD + 10g咖啡豆=80g!

大约是香蕉重量的一半，轻松享受户外咖啡。

M 尺寸：44g，320ml。 大容量，能装更多的饮品和食物。

超轻户外钛杯

¥198 | 180ml：W110mm x D84mm x H56mm 34g

¥228 | 320ml：W140mm x D100mm x H65mm 44g

钛材质 | 中国制造 | 50/箱



新品



真空结构可长时间保温，冷饮热饮都可。自带可拆卸滤网，可泡咖啡、花茶、果茶等。带有温度计，可随时了解温度（饮品上部和底部会有些许温差）。底部可拆卸木质脚架，可直接把桶身放桌上。市场上非常少的5L容量，非常适合家庭或小型聚会、餐饮馆使用。

Thermo Jug Cask 保温桶 5L

¥1180 | W216mm x D267mm x H480mm (包括支脚)
W216mm x D267mm x H335mm (仅桶身)
2.84公斤 | 口径: 105mm

18-8 不锈钢 (桶身) / 聚丙烯 (桶身、盖子、过滤器) / 硅橡胶 (盖子、桶身/尼龙 (过滤器) / 温度计 / ABS 树脂 (桶身) | 中国制造
耐热度 / 70.4℃ 以上 (10小时) | 耐冷度 / 7.4℃ 以下 (6小时) | 4/箱



保温壶更新升级版，保温性能更加好，新增加一个盖子更易清洗。增加了1.6L大容量规格，增加灰蓝、卡其2色。使用天然树木作为手柄，款式简洁大方，还设计了能够以轻轻力量就能旋转的瓶盖和可单触开关的壶，颜值和功能兼备。

Thermo Jug Keat 咖啡壶 (升级)

¥428 | 1600ml: W207mm*H200mm*D146mm 833g
¥388 | 1200ml: W207mm*H212mm*D130mm 788g

18-8 不锈钢 (主体/上盖)、聚丙烯 (主体上部, 上盖) 榉木 (手柄)
中国制造 | 10小时64℃ | 6/箱





天然木材制成，每块颜色均不用，让支架更有质感和稳定。真皮制成的皮带，让支架在户外使用中不易丢失，可以挂在任何您方便拿取的地方。

咖啡滴滤支架

¥98
W120mm x D70mm x H10mm



天然木材（相思木），天然皮革 | 中国制造 | 100/箱



硅胶材质让翻面轻而易举，折叠后收纳随行杯中。CAVE滤杯的耐用材质，就算高处跌落也不会损坏，是您户外的完美伴侣。2面不同的设计，满足您多重冲煮方式。

Cave Reversible 折叠滤杯

¥108
D10mm x H9mm



89g | 硅胶 | 中国制造 | 16/箱



可爱的周边，整体是汉堡的造型，但分开每个配件都可随心使用。“牛肉”“奶酪”“番茄”可用作杯垫；“生菜”的中间有一个大洞，可用作滤杯支架；两片小面包可倒置成一个小托盘，让您享受咖啡与巧克力或饼干的搭配。

Stax Plus汉堡杯垫

¥298
W106mm*H84mm*D106mm
248g



天然木材（松木）涂层类型：漆面涂料，水性涂料
中国制造 | 24/箱



复古工业质感餐盒，不锈钢材质更耐用更易清洗。密封设计，方便出行。餐盒盖子也可当做餐盘使用。耐水洗餐盒袋的双面设计，不惧怕食物的意外洒出，亦可用作午餐垫。

SOL餐盒+餐盒袋子

餐盒：¥318
W176mm x D121mm x H62mm 700ml
袋子：¥98
W290mm x D320mm x H12mm

不锈钢，硅橡胶，棉 | 中国制造



世界上最小的手冲咖啡滴滤器。它紧凑造型，携带十分方便，V字型滤网，萃取稳定。带上它你可随时随地享用美味咖啡。可以拆卸，收到杯子里。

MCD 便携式咖啡滴滤

¥69
W81mmxH46mm
重量:37g



橄榄绿

黑色

浅褐色

聚丙烯(过滤器)/不锈钢(网状)/硅橡胶(支架)
中国制造 | 50/箱

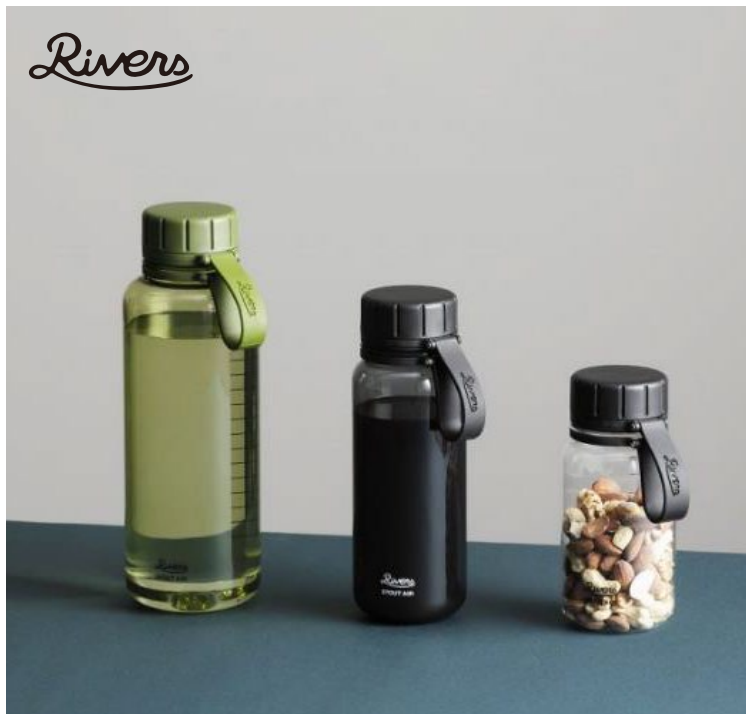

户外轻量级水杯。杯盖有硅胶表带，可用登山扣挂起。杯子内盖有防溅罩，在户外高低不平的地上移动时，水不易倒出。

STOUT AIR 随行杯

400ml : ¥118
W100mm×H157mm×D71mm
550ml : ¥121
W100mm×H204mm×D71mm
1000ml : ¥148
W117mm×H250mm×D85mm



共聚酯*PET, 聚丙烯, 硅橡胶, 不锈钢 | 中国制造 | 耐热度 / 90°C
耐冷度 / -40°C | 50/箱 (400ml/550ml) | 20/箱 (1000ml)



卓越保温，暖意持久，精工制作。瓶身仅200g（不含表带），比单个苹果都轻超轻瓶身。可拆卸表带，任何地方都可挂取，出门方便携带。

STEM BL 保温杯 500ml

¥299 | 500ml
W80mm（包括表带）x D70mm x H225mm



不锈钢（主体）/聚丙烯（盖子、挂钩）/聚酯（魔术贴，标签）/硅橡胶（内塞）
73° C或更高（6小时）7° C以下（6小时）| 中国制造 | 24/箱 | 230g



坚固又有良好的保温效果。
使用厚不锈钢作为材料，具有很高的耐用性。
它的设计使其在跌落时不会轻易损坏真空结构。

Rivers Stout 保温杯

¥ 278 | 700ml: D73m×H265mm



卡其色, 黑色, 白色, 不锈钢色, 浅褐色
不锈钢（瓶体）/聚丙烯（盖子、中栓）/硅胶（盖子、瓶栓）
中国制造 | 24/箱 (500ml) | 12/箱 (700ml/1000ml)

MiiR[®]

为了赋予人们更美好的未来



Thermo 3DTM

最好的双层真空保温材料，长效保温保冷。



HardshellTM 粉末涂层

耐用涂层表面并保护产品的外观。



不串味

18-8医用级不锈钢，不串味或不留金属余味。



不含BPA

所有的MiiR产品都保证100%不含BPA。



兼容汽车杯架

设计使您的饮料保持固定，并在您驾驶汽车的狂野旅程中保持直立。



防漏设计

完美的Seal杯盖技术可确保杯子的密封性，使液体不泄露。



18-8不锈钢

我们使用含有18%铬和8%镍的最高质量医用不锈钢，使产品更安全耐用



杯身抗冷凝

双层结构的杯身可消除冷凝，保持双手干爽。



We exist to empower people for a better future.

MiiR 是一家以社会和环境为使命的高端饮具公司。也是一家经过认证的、独立拥有和经营的B公司，MiiR在商业需求之外，更多关注慈善和环保，且在弥合商业和慈善之间的鸿沟，一直在以下三大关键领域推动真正的、可持续的发展。

我们相信，通过商业也能赋予世界各地更美好的生活。无论您的客户在户外游玩时，想喝一杯高品质咖啡，还是仅仅需要企业之间的社交，我们都是具有实际影响力的合作伙伴，能为您提供高品质产品。

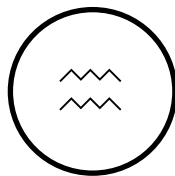

清洁水

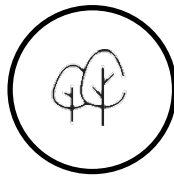

健康环境



壮大社区







360 旅行保温杯

12oz/354ml

零售价：¥278

24个/箱



16oz/473ml

零售价：¥309

24个/箱



可定制杯型（需另收费）

360可出水杯盖，让使用更便捷。按下盖子中央按钮，可从任何一边饮水，再按一下可关闭。



儿童保温杯

12oz/354ml

零售价：¥288

24个/箱



可定制杯型（需另收费）

不仅适合儿童，任何人都可轻松打开或关闭出水口。



吸管杯

32oz/956ml
 零售价：¥368
 12个/箱



可定制杯型（需另收费）

大容量吸管杯，让您全天保持水分-从健身房到办公桌。
 密封保温，防止溢出，放在身边看起来也很漂亮。



威士忌杯

10oz/296ml
 零售价：¥278
 24个/箱



14oz/414ml
 零售价：¥308
 24个/箱



抓住传统的威士忌酒杯怀旧之情，酒吧必备品。杯底加重设计，让酒杯更有质感，更稳。双层隔热层使威士忌酒保持凉爽，托迪酒保持热度。

MiiR[®]

Climate+ 气候+ 随行杯

MiiR 的“气候+”独树一帜，不锈钢减少 25%，碳足迹抵消了 110%。同时保持 Thermo 3D[®] 双壁真空绝缘。

可定制杯型

定制工艺：激光/丝印/水贴膜（需另收费）



16oz/473ml
零售价：¥318
24个/箱

20oz/591ml
零售价：¥348
24个/箱

12oz/354ml
零售价：¥298
24个/箱



新品

MiiR[®]

露营杯

通过对旧代露营杯的重新设计，那些篝火边的回忆更加温暖了吧！Thermo 3D™双层真空隔热防烫手防烫嘴，为您的办公室和营地囤一个吧！

热门制杯型

定制工艺：激光/丝印/水贴膜（需另收费）



8oz/236ml (多色)

零售价：¥ 238

箱规：24个

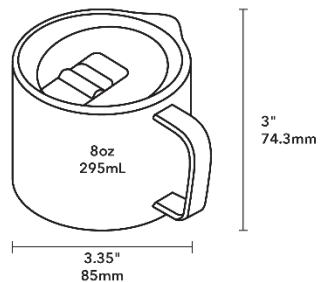

12 oz/354 ml (多色)

零售价：¥ 278

箱规：24个

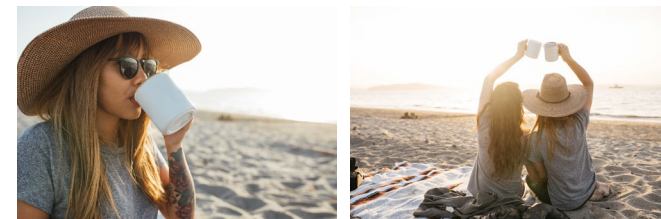
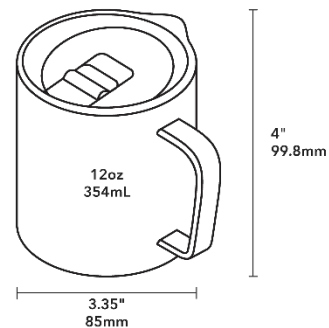

Miir®

双层咖啡杯

设计灵感来自于外带纸杯，造型简约，易携带，适合日常生活。

热门制杯型

定制工艺：激光/丝印/水贴膜（需另收费）



6oz / 177ml

零售价：¥185

尺寸：53 X 70 X 105mm

箱规：24个

8oz / 237ml (3色)

零售价：¥208

尺寸：53 X 70 X 124mm

箱规：24个

12oz / 354ml (多色)

零售价：¥228

尺寸：63 X 82 X 139mm

箱规：24个





宽口保温杯

宽口系列易于存放冰块，携带和清洁。采用Thermo 3D™双壁真空保温，宽口瓶可以让任何饮料在数小时内保冷保热。

16oz / 473ml (2色)

零售价：¥308

尺寸：70 X 228mm

箱规：30个

20oz / 591ml (有12色)

零售价：¥319

尺寸：70 X 266mm

箱规：30个 或 24个



旅行保温杯系列

使用防漏、隔热锁扣翻盖，来解决最颠簸的出行。无论飞机，火车，汽车旅行或是骑山地自行车冒险，旅行保温杯都会很快成为你最好的旅行伴侣。

12oz / 354ml (有10色)

零售价：¥278

尺寸：159 X 70mm

箱规：30个 或 24个

16oz / 473ml (有8色)

零售价：¥309

尺寸：184 X 70mm

箱规：30个 或 24个



红酒系列

Miir葡萄酒系列均采用先进的Thermo 3D™双层真空保温技术，采用经典的设计和标志性外形，在常温下保持葡萄酒或其它饮品持续低温数小时。

红酒杯

10oz / 296ml (有2色)

零售价：¥228

重量：240克

尺寸：82 X 110mm

箱规：30个



咖啡豆罐

可装12盎司咖啡豆

咖啡的新鲜度要求完美的环境，而Miir咖啡罐能提供这样的环境。创新的手风琴式密封去除氧气和锁住咖啡风味，轻松抓握，简单的扭转挡板盖完成关闭。它简洁的外形可以装在任何厨房的柜台上，也可以随身携带。

零售价：¥309

尺寸：97 X 165mm

箱规：30个



品脱杯

来自经典啤酒罐的设计，杯子上边缘有一个连续的扭转。两者均由单层医用级18-8不锈钢制成，不含双酚A，能保持饮料风味。可堆叠，易于清洁。杯子，花瓶，小吃架，蚂蚁城堡，MiiR品脱杯可用于多种用途。

16 oz/480ml

零售价：¥ 128

尺寸：82X 133 X 57mm

箱规：30个



Pourigami™咖啡滤杯

1人份咖啡滤杯

旅行时别再喝普通的咖啡了，享受Pourigami™咖啡滤杯的三重功效。世界上最小、最耐用和最便携的扁平包装滤杯。三个互锁不锈钢面板使，比千纸鹤更容易组装，重量刚好足够稳定，并且有指定的槽口以防止其偏离中心。随附的袋子便于您在路上存放及携带滤杯，有携带并存放过滤器的空间。

零售价：¥ 299

3片不锈钢板

重量：113克

尺寸：63.5 X 130 X 2.3mm (未组装)



卢旺达限定系列

MiiR®



CAMP CUP
12OZ | 354ML

营地杯 12oz/354ml

零售价：¥298

30个/箱

WIDE MOUTH BOTTLE
16OZ | 473 ML

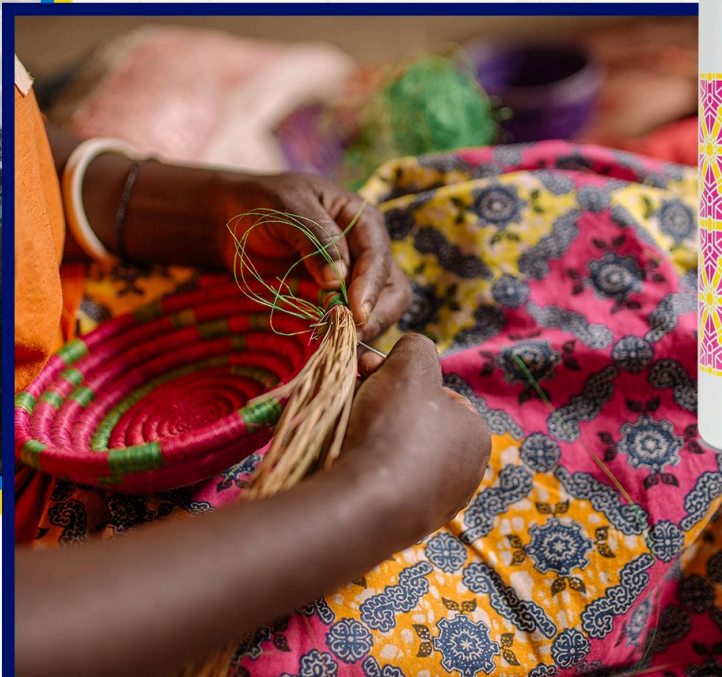

宽口保温杯 16oz/473ml

零售价：¥309

30个/箱



TRAVEL TUMBLER
12OZ | 354 ML

旅行保温杯 12oz/354ml

零售价：¥298

30个/箱

KINTO



“舒适”与“外表”之间的和谐

精美的餐具将自然融入您的生活空间，并为您的日常生活增添色彩。

1972年成立于日本彦根市。

2016年成立欧洲子公司KINTO Europe BV

2019年成立美国子公司KINTO USA, Inc.

专业设计和开发餐具，饮料器皿，室内装饰品。

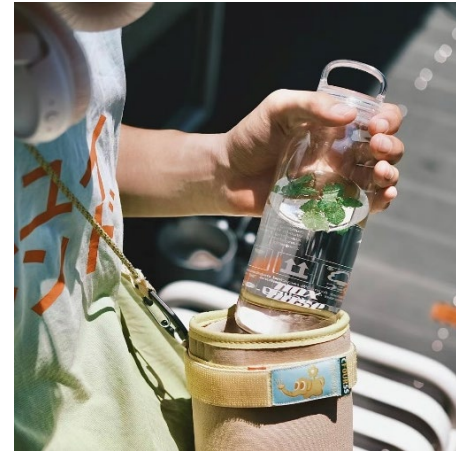

KINTO



- 出水口无螺纹，饮水感更佳。
- 手提盖便于携带，可轻松打开或盖上，并且可覆盖出水口，用于户外更安全。

新品

KINTO TRAIL TUMBLER 手提保温杯

¥308 | 350ml: $\phi 77 \times H240\text{mm}$ 350g 24个/箱

¥388 | 1080ml: $\phi 88 \times H312\text{mm}$ 500g 24个/箱

18-8不锈钢、硅橡胶 / 不含BPA | 中国制造



硅胶部件可拆卸，
瓶内底圆形设计，
可防止污垢堆积，也便于卫生。

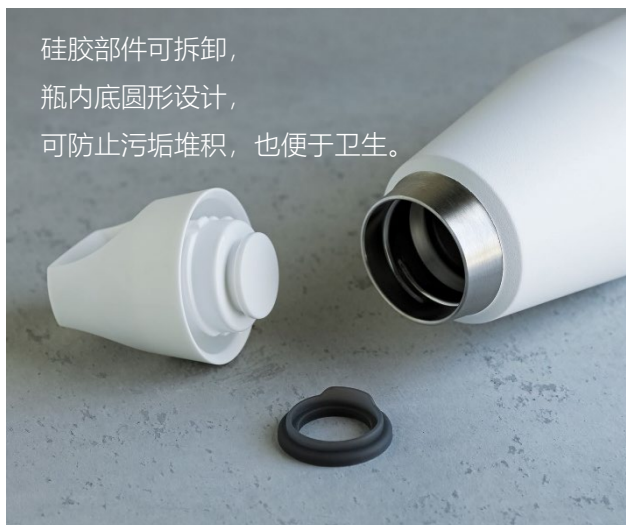



网红款正版保温杯，双层真空不锈钢保温，箔层将热量反射顶部，优异的冷热保温。可旋转茶漏口设计，大小口均可饮水，大口方便清洗和放置冰块。外杯身磨砂涂层，更有质感并且耐用。

KINTO TRAVEL TUMBLER 旅行保温杯

¥258 | 350ml: $\phi 70 \times H170$ mm 243g 24个/箱
 ¥278 | 500ml: $\phi 73 \times H197$ mm 311g 24个/箱



18-8不锈钢 (SUS-304), 聚丙烯, 硅橡胶
 中国制造 | 1小时90°C 6小时70°C 6小时7°C |



独特的手提款设计，轻轻一提，出门便利。双层真空不锈钢保温，优异的冷热保持。可旋转茶漏口设计，大小口均可饮水，大口方便清洗和放置冰块。外杯身磨砂涂层，更有质感并且耐用。

KINTO DAY OFF TUMBLER 保温杯

¥265
 $\phi 74 \times H226$ mm
 500ml | 308g | 24个/箱



18-8不锈钢 (SUS-304), 聚丙烯, 硅橡胶
 中国制造 | 1小时90°C 6小时70°C 6小时7°C |

KINTO



专为运动的你打造，即使在运动时也能轻易打开或关闭饮水口，给您舒适的饮水体验。超大的杯口，轻易放入冰块也方便清洗。杯底附有高弹性缓冲垫，不怕任何地面磨损。杯身采用双层真空不锈钢，可长时间保冷，炎炎夏日有个舒畅的运动时光。

KINTO ACTIVE 运动保温杯

¥298 | 600ml: $\phi 80 \times H220$ mm 350g 24个/箱
¥358 | 800ml: $\phi 80 \times H268$ mm 418g 12个/箱



18-8不锈钢 (SUS-304), 聚丙烯, 硅橡胶
6°C以下 (6小时) | 中国制造 |



专为儿童设计，也是运动好搭档。带有吸管设计，可以取出单独使用。大杯口方便置放冰块，亦方便清洗。采用真空双层设计，保温保冷性能优秀。杯口带有小耳朵设计，方便携带。

KINTO PLAY TUMBLER 儿童保温杯

¥245
 $\phi 69 \times H161 \times W 95$ mm
300ml | 200g | 24个/箱



18-8不锈钢 (SUS-304), 聚丙烯, 硅橡胶
中国制造 | 7°C以下 (6小时) | 24个/箱



可用在任何场景的杯子，杯口直接有饮水口，无需打开杯盖。杯体由双层真空高品质不锈钢制成，可持续保持饮品的温度与风味。内壁点解抛光工艺，不易附着茶或咖啡渍，易清洗。外币磨砂涂层，质感好且耐用。杯子超适合拿铁，透明盖子可以看到饮品余量。

KINTO TO GO TUMBLER 随行杯

¥246 | 240ml: $\phi 86 \times H90$ mm 185g 24个/箱
 ¥258 | 360ml: $\phi 86 \times H128$ mm 230g 24个/箱



18-8不锈钢、树脂、硅胶
 中国制造 | 1小时65°C 2小时10°C |



为夏日运动而生，材质轻便，硅胶提环，出行轻便。大小2个口设计，小口饮水，大口方便放置冰块柠檬等，亦方便清洗。杯身自带容量刻度，保证夏季运动补水量。

KINTO WORKOUT BOTTLE 运动随行瓶

¥198
 $\phi 75 \times H265$ mm
 480ml

PCT树脂，硅橡胶
 耐热温度：80°C/耐寒温度：-20°C | 中国制造 | 24个/箱





不锈钢和玻璃的组合，功能性和美感兼备。倒水无需打开，防止灰尘进入，壶嘴不易滴液设计，方便卫生。附带细小网状滤网，适合咖啡粉，夏季冷泡好物。大杯口清洗方便。

KINTO LUCE 水壶+冷萃壶

¥358 | 750ml水壶：φ100 x H200 mm 12个/箱

¥458 | 1L 水壶：φ105 x H250 mm 12个/箱

¥508 | 1L冷萃壶：φ105 x H250 mm 12个/箱

耐热玻璃、不锈钢、PET | 中国制造



咖啡或者冷泡利器，玻璃和树脂结合，可放入冰箱。细小的滤网，不留咖啡渣或者茶叶渣。可拿掉滤网使用，用作日常冷水壶。

KINTO CAPSULE 玻璃壶

¥219

φ85 x H270 mm

1L

ABS树脂，不锈钢，PP，PET | 中国制造





KINTO

采用不易划伤不易开裂的高品质树脂，超透明，超好质感，装入液体更好美丽。手提瓶盖适合，旋转容易，轻巧便携。

KINTO WATER BOTTLE 水瓶

¥96 | 300ml: φ65x H155mm 60g 48个/箱
 ¥115 | 500ml: φ70x H200mm 75g 24个/箱
 ¥188 | 950ml: φ93x H246mm 120g 24个/箱



饱和聚酯树脂，硅胶 | 中国制造



双层瓶体设计，饮品有悬浮美感，且不易有冷凝水珠，冰块不易融化，夏日享受长时间的凉爽。饮用口采用柔软的硅胶材质，使用舒适。可手提的瓶盖设计，轻松便携。

KINTO TO GO 随行瓶

¥215 | 360ml: φ78x H195mm 200g 24个/箱
 ¥225 | 480ml: φ78x H240mm 245g 24个/箱



饱和聚酯树脂，硅胶 | 中国制造

KINTO



基于八角形设计的OCT系列咖啡器具，讲阴影的线条美感发挥极致，而内部制作保留圆润的样貌，设计独特使用舒适。不仅是设计有美感，放置在家里也是为家里添光彩的美物。



KINTO OCT咖啡杯+分享壶 (都有黑白2色)

- | | | | |
|--|---|---|---|
|  ¥118
2杯份 |  ¥208
4杯份 |  ¥108
300ml |  ¥128
300ml |
|  ¥138
80ml |  ¥168
220ml |  ¥188
300ml |  ¥148
600ml |

陶瓷 日本制造 | 玻璃 中国制造



SEPIA系列，就像在跳蚤市场寻到的古董一样，给人一种怀旧质感，让人感受咖啡或茶的宁静。杯底凸出设计，杯子之间可以相互重叠紧凑收纳。耐热玻璃制成，不管是冷热的咖啡都能享用。



KINTO SEPIA 玻璃杯+分享壶

- | | | | |
|---|---|---|---|
|  ¥108
270ml |  ¥118
370ml |  ¥225
270ml套装 | |
|  ¥132
270ml |  ¥140
340ml |  ¥198
430ml |  ¥228
750ml |

耐热玻璃、柚木 | 中国制造

KINTO

SLOW COFFEE STYLE SPECIALTY



TOTEM



HIBI



AQUA CULTURE VASE



ALFRESCO



POUR OVER KETTLE



LUNA



RIPPLE



BOTTLIT



CARAT



SLOW COFFEE STYLE



FOG



SEPIA



KAKOMI



UNITEA





Thank You !

宁波市瑾坤科技发展有限公司
info@greencoastcoffee.com
0574-88227882
www.greencoastcoffee.com